

Tube Fitting

***Maintaining basic functions,
this low-cost quick-fitting joint
achieves high-cost performance.***

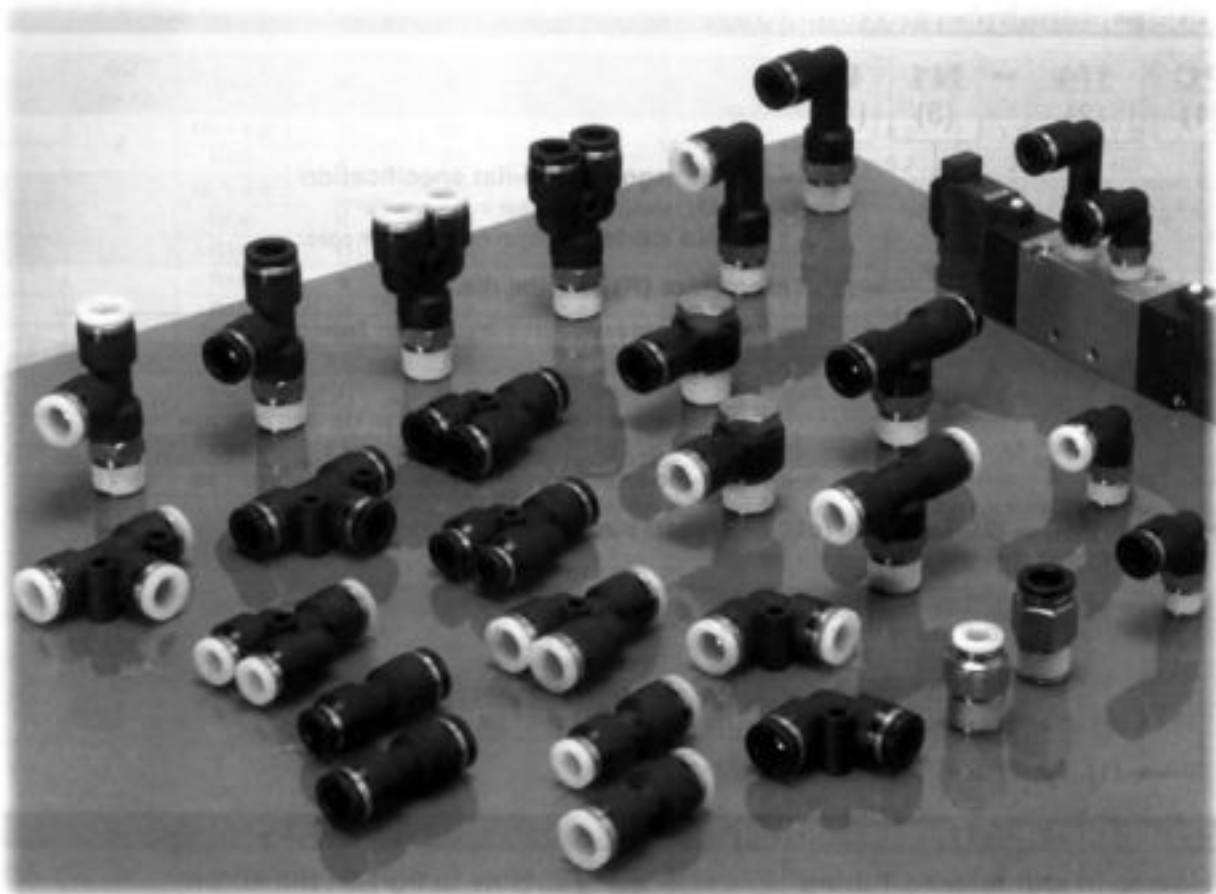

- *The Tube Fitting comes in a wide variety of tube and thread sizes.*
- *Even after installation the direction of the tubing can be changed freely (Elbow, Long Elbow, Universal Elbow, etc.).*

Construction

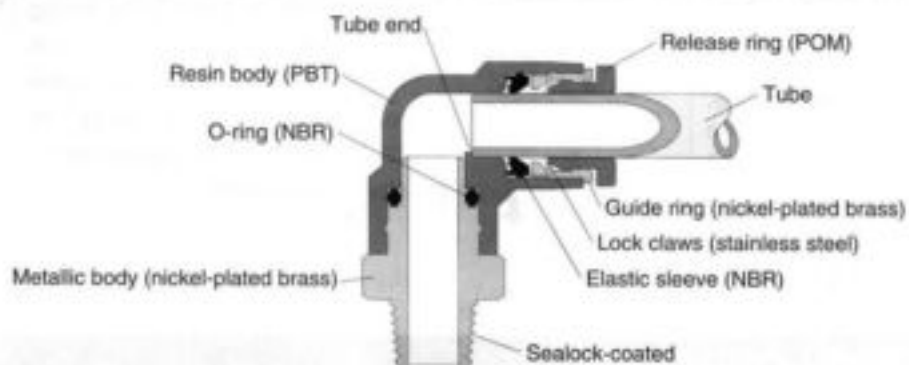

Tube Fitting

Specification

Fluid admitted	Air, water (conditional ^{*1, *2, *3})
Max. Service pressure	0.9MPa (9.18kgf/cm ²)
Negative pressure	-100kPa (-750mmHg)
Service temperature range	0 ~ 60°C

*1. When it is used with water, please make sure that surge pressure is lower than Max. service pressure range.

*2. Fresh water is applicable. Please make an inquiry for other fluid uses.

*3. When it is used with water, be sure to install the insert ring.

Model Designation (example)

PC (1) **1/4** (2) - **N1** (3) **U** (4) **T**

(4). Hexagon flat-to-flat specification

U: Hexagon flat-to-flat inch spec. (NPT)

No code: Hexagon flat-to-flat mm spec.

(3). Thread size (R) or Tube dia. (oD)

	Metric thread	Taper pipe thread			
Code	M5	01	02	03	04
Size	M5×0.8	R1/8	R1/4	R3/8	R1/2
	Unified fine thread	American standard taper pipe thread			
Code	U10	N1	N2	N3	N4
Size	10-32UNF	NPT1/8	NPT1/4	NPT3/8	NPT1/2

(2). Tube dia. (oD) or Thread size (R)

	mm size				
Code	4	6	8	10	12
Dia. (mm)	4	6	8	10	12
	inch size				
Code	5/32	1/4	5/16	3/8	1/2
Dia. (inch)	5/32	1/4	5/16	3/8	1/2

(1). Type

Connection and Disconnection

1. How to fit and release Tubing

(1). Tube insertion

Simply insert a tubing to the tube end of Tube Fitting. The lock claws automatically fix the tubing, and the elastic sleeve seals the tube surrounding. Please refer to "2. Cautions on the fitting of tube" in "Common Safety Instructions for Quick-Fitting Joint" for other instructions.



(2). Tube release

In case of releasing the tube, push the release ring. The lock claws open and the tube can be released. Before releasing the tube, make certain that the pressure inside the tube is zero pressure.



2. How to tighten the screw

For the type of tightening outside hexagon, apply a spanner or an impact wrench.

For the type of tightening inside hexagon (This enables to space Tube Fittings closer), apply a Hex Keys. (Please refer to the text for detail.)

Please refer to Table 3 Tightening Torque, Sealock color and Gasket Material in "4. Cautions on the installation of joint body" in "Common Safety Instructions for Quick-Fitting Joint".

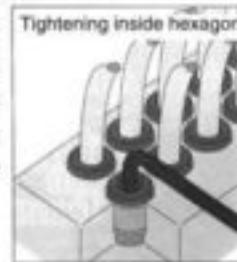

▲ Detailed Safety Instructions

Before using the PISCO device, be sure to read the "Safety Instructions", "Common Safety Instructions for Products Listed in This Manual" on page 19 to 21 and "Common Safety Instructions for Quick-Fitting Joint" on page 22 to 23.

Warning

1. When the fluid admitted is water, do not use the PISCO device unless the application satisfies all the conditions required in specifications. Otherwise damage may be caused to the joint body, the tube may come off or leakage may result.

PC Straight



Appearance Dimension for Metric thread

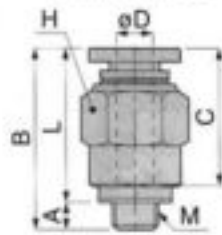

Appearance Dimension for Taper pipe thread (PT)

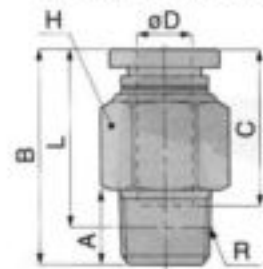

Unit: mm

Model	OD (Tube dia.)	M/R	A	B	L	C	H (Hex.)	Weight (g)	Orifice dia. (mm)	Eff. sect. Area (mm ²)	Cv
PC4-M5T	4	M5×0.8	3	20	17	14.9	10	6.2	1.8	1.9	0.10
PC4-01T		R1/8	8	21				8.2	3	5.3	0.29
PC6-M5T	6	M5×0.8	3	22.1	19.1	17	12	9.2	1.8	1.9	0.10
PC6-01T		R1/8	8	22.6	18.6			9.1	4.6	12.5	0.68
PC6-02T		R1/4	11	24.6	18.5			17.2			
PC8-01T	8	R1/8	8	27.9	23.9	18.2	14	15.5	6	20	1.08
PC8-02T		R1/4	11	26.6	20.8			15.6			
PC8-03T		R3/8	12	23.9	17.6			23.6			
PC10-02T	10	R1/4	11	29.8	23.8	20.7	17	20.5	8.5	35	1.90
PC10-03T		R3/8	12	29.3	23			26			
PC12-03T	12	R3/8	12	31.9	25.6	23.3	21	35.7	11	59	3.20
PC12-04T		R1/2	15	33.9	25.7			50.1			



Appearance Dimension for Unified thread

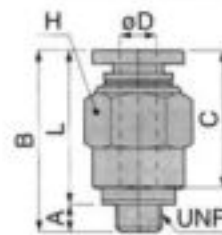

Appearance Dimension for Pipe thread general purpose (NPT)

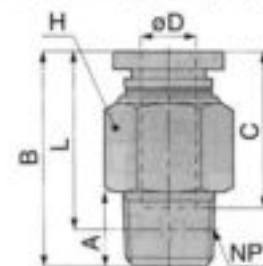

Unit: mm

Model	OD (Tube dia.)	UNF/NPT	A	B	L	C	H (Hex.)	Weight (g)	Orifice dia. (mm)	Eff. sect. Area (mm ²)	Cv
PC5/32-U10UT	5/32	No. 10-32UNF	3	20	17	14.9	7/16	6.2	1.8	1.9	0.10
PC5/32-N1UT		NPT1/8	8	21				16.9	8.2	3	5.3
PC1/4-U10UT	1/4	No. 10-32UNF	3	22.1	19.1	17	1/2	9	1.8	1.9	0.10
PC1/4-N1UT		NPT1/8	8	22.6	18.4			9.1	4.6	12.5	0.68
PC1/4-N2UT		NPT1/4	11	24.6	18.8			17.2			
PC5/16-N1UT	5/16	NPT1/8	8	27.9	23.8	18.2	9/16	15.5	6	20	1.08
PC5/16-N2UT		NPT1/4	11	26.6	20.8			15.6			
PC5/16-N3UT		NPT3/8	12	23.9	17.8			23.6			
PC3/8-N2UT	3/8	NPT1/4	11	29.8	24	20.7	11/16	20.5	8.5	35	1.90
PC3/8-N3UT		NPT3/8	12	29.3	23.2			26			
PC1/2-N3UT	1/2	NPT3/8	12	31.9	25.8	23.3	7/8	35.7	11	59	3.20
PC1/2-N4UT		NPT1/2	15	33.9				50.1			

PU Union Straight

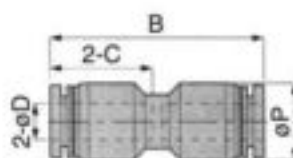

Unit: mm

Model	OD (Tube dia.)	B	C	øP	Weight (g)	Orifice dia. (mm)	Eff. sect. Area (mm ²)	Cv
PU4T	4	30.8	14.9	10	4.9	2.8	3.8	0.21
PU6T	6	34.9	17	12.5	6.8	4.3	11.4	0.62
PU8T	8	37.8	18.4	14.5	9.3	5.9	25.4	1.38
PU10T	10	41.4	20.2	17.5	15.5	8.3	36.7	1.99
PU12T	12	47.8	23.4	21	22.6	9.9	47.4	2.57

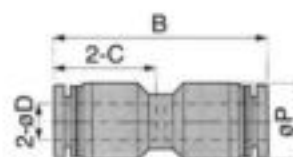

Unit: mm

Model	OD (Tube dia.)	B	C	øP	Weight (g)	Orifice dia. (mm)	Eff. sect. Area (mm ²)	Cv
PU5/32T	5/32	30.8	14.9	10	4.9	2.8	3.8	0.21
PU1/4T	1/4	34.9	17	12.5	6.8	4.3	11.4	0.62
PU5/16T	5/16	37.8	18.4	14.5	9.3	5.9	25.4	1.38
PU3/8T	3/8	41.4	20.2	17.5	15.5	8.3	36.7	1.99
PU1/2T	1/2	47.8	23.4	21	22.6	9.9	47.4	2.57

PG Different Diam. Union Straight

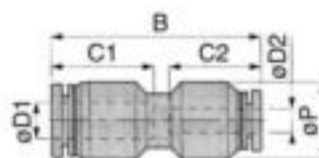

Unit: mm

Model	ØD1 (Tube dia.)	ØD2 (Tube dia.)	B	C1	C2	øP	Weight (g)	Orifice dia. (mm)	Eff. sect. Area (mm ²)	Cv
PG6-4T	6	4	34.4	17	14.9	12.5	6.6	2.8	4.9	0.27
PG8-6T	8	6	37.9	18.4	17	14.5	8.8	4.3	6.3	0.34
PG10-8T	10	8	41.1	20.2	18.4	17.5	13.9	5.9	28.8	1.56
PG12-10T	12	10	47.8	23.4	20.2	21	21.7	8.3	39.9	2.16

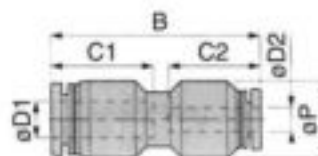

Unit: mm

Model	ØD1 (Tube dia.)	ØD2 (Tube dia.)	B	C1	C2	øP	Weight (g)	Orifice dia. (mm)	Eff. sect. Area (mm ²)	Cv
PG1/4-5/32T	1/4	5/32	34.4	17	14.9	12.5	6.6	2.8	4.9	0.27
PG5/16-1/4T	5/16	1/4	37.9	18.4	17	14.5	8.8	4.3	6.3	0.34
PG3/8-5/16T	3/8	5/16	41.1	20.2	18.4	17.5	13.9	5.9	28.8	1.56
PG1/2-3/8T	1/2	3/8	47.6	23.4	20.2	21	21.7	8.3	39.9	2.16

PL Elbow



Appearance Dimension for Metric thread

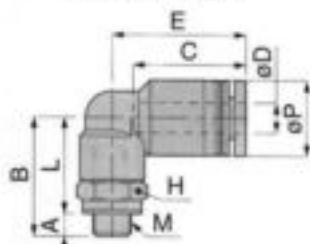

Appearance Dimension for Taper pipe thread (PT)

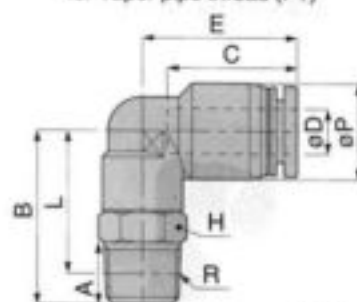

Unit: mm

Model	OD (Tube dia.)	M/R	A	B	L	E	C	eP	H (Hex.)	Weight (g)	Orifice dia. (mm)	Eff. sect. Area (mm ²)	Cv
PL4-M5T	4	M5×0.8	3	16	13	17.7	14.9	10	8	5.7	2.4	3.7	0.20
PL4-01T		R1/8	8	22	18	18.7			10	10.9	2.8	4.5	0.24
PL6-M5T	6	M5×0.8	3	19.5	16.6	20.3	17	12.5	10	13	1.8	1.5	0.08
PL6-01T		R1/8	8	22.5	18.5					11.9	4	9	0.49
PL6-02T		R1/4	11	28	22					21.8	14	20	4.3
PL8-01T	8	R1/8	8	23	19	22.7	18.4	14.5	12	13.7	6	18.8	1.02
PL8-02T		R1/4	11	28	22	23.7			14	21.5	6.4	23.5	1.27
PL8-03T		R3/8	12	31	24.7	24.7			17	34.5	6.4	20.3	1.10
PL10-02T	10	R1/4	11	28.5	22.5	26	20.2	17.5	14	24.7	7.5	29.5	1.60
PL10-03T		R3/8	12	32	25.7	27			17	37.7	8.2	32.1	1.74
PL12-03T	12	R3/8	12	32.5	26.2	29.7	23.4	21	17	41.4	9	43	2.33
PL12-04T		R1/2	15	36.5	28.3				21				

Appearance Dimension for Unified thread

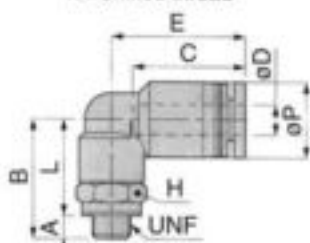

Appearance Dimension for Pipe thread general purpose (NPT)

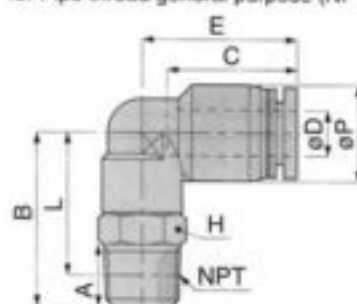

Unit: mm

Model	OD (Tube dia.)	UNF/NPT	A	B	L	E	C	eP	H (Hex.)	Weight (g)	Orifice dia. (mm)	Eff. sect. Area (mm ²)	Cv
PL5/32-U10UT	5/32	No. 10-32UNF	3	16	13	17.7	14.9	10	5/16	5.7	2.4	3.7	0.20
PL5/32-N11UT		NPT1/8	8	22	17.9	18.7			7/16	10.9	2.8	4.5	0.24
PL1/4-U10UT	1/4	No. 10-32UNF	3	19.5	16.6	20.3	17	12.5	7/16	13	1.8	1.9	0.10
PL1/4-N11UT		NPT1/8	8	22.5	18.4					11.9	4	9	0.49
PL1/4-N2UT		NPT1/4	11	28	22.2					21.8	9/16	20	4.3
PL5/16-N11UT	5/16	NPT1/8	8	23	18.9	22.7	18.4	14.5	1/2	13.7	6	18.8	1.02
PL5/16-N2UT		NPT1/4	11	28	22.2	23.7			9/16	21.5	6.4	23.5	1.27
PL5/16-N3UT		NPT3/8	12	31	24.9	24.7			11/16	34.5	6.4	20.3	1.10
PL3/8-N2UT	3/8	NPT1/4	11	28.5	22.7	26	20.2	17.5	9/16	24.7	7.5	29.5	1.60
PL3/8-N3UT		NPT3/8	12	32	25.9	27			11/16	37.7	8.2	32.1	1.74
PL1/2-N3UT	1/2	NPT3/8	12	32.5	26.4	29.7	23.4	21	11/16	41.4	9	43	2.33
PL1/2-N4UT		NPT1/2	15	36.5	28.4				7/8				

PL Elbow



Appearance Dimension for Metric thread

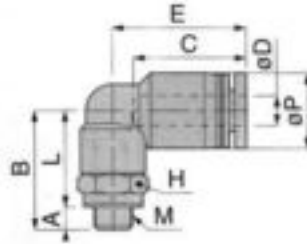

Appearance Dimension for Taper pipe thread (PT)

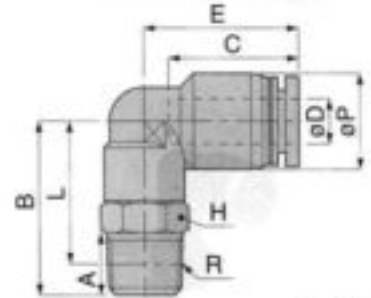

Unit: mm

Model	OD (Tube dia.)	M/R	A	B	L	E	C	oP	H (Hex.)	Weight (g)	Orifice dia. (mm)	Eff. sect. Area (mm ²)	Cv
PL4-M5T	4	M5×0.8	3	16	13	17.7	14.9	10	8	5.7	2.4	3.7	0.20
PL4-01T		R1/8	8	22	18	18.7			10	10.9	2.8	4.5	0.24
PL6-M5T	6	M5×0.8	3	19.5	16.6	20.3	17	12.5	10	13	1.8	1.5	0.08
PL6-01T		R1/8	8	22.5	18.5				11.9	4	9	0.49	
PL6-02T		R1/4	11	28	22				21.8	14	20	4.3	10
PL8-01T	8	R1/8	8	23	19	22.7	18.4	14.5	12	13.7	6	18.8	1.02
PL8-02T		R1/4	11	28	22	23.7			14	21.5	6.4	23.5	1.27
PL8-03T		R3/8	12	31	24.7	24.7			17	34.5	6.4	20.3	1.10
PL10-02T	10	R1/4	11	28.5	22.5	26	20.2	17.5	14	24.7	7.5	29.5	1.60
PL10-03T		R3/8	12	32	25.7	27			17	37.7	8.2	32.1	1.74
PL12-03T	12	R3/8	12	32.5	26.2	29.7	23.4	21	17	41.4	9	43	2.33
PL12-04T		R1/2	15	36.5	28.3				21				

Appearance Dimension for Unified thread

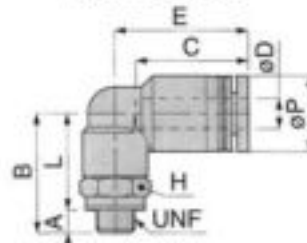

Appearance Dimension for Pipe thread general purpose (NPT)

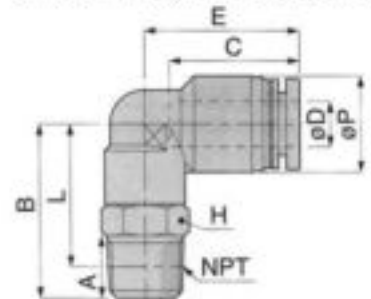

Unit: mm

Model	OD (Tube dia.)	UNF/NPT	A	B	L	E	C	oP	H (Hex.)	Weight (g)	Orifice dia. (mm)	Eff. sect. Area (mm ²)	Cv
PL5/32-U10UT	5/32	No. 10-32UNF	3	16	13	17.7	14.9	10	5/16	5.7	2.4	3.7	0.20
PL5/32-N1UT		NPT1/8	8	22	17.9	18.7			7/16	10.9	2.8	4.5	0.24
PL1/4-U10UT	1/4	No. 10-32UNF	3	19.5	16.6	20.3	17	12.5	7/16	13	1.8	1.9	0.10
PL1/4-N1UT		NPT1/8	8	22.5	18.4				11.9	4	9	0.49	
PL1/4-N2UT		NPT1/4	11	28	22.2				21.8	9/16	20	4.3	10
PL5/16-N1UT	5/16	NPT1/8	8	23	18.9	22.7	18.4	14.5	1/2	13.7	6	18.8	1.02
PL5/16-N2UT		NPT1/4	11	28	22.2	23.7			9/16	21.5	6.4	23.5	1.27
PL5/16-N3UT		NPT3/8	12	31	24.9	24.7			11/16	34.5	6.4	20.3	1.10
PL3/8-N2UT	3/8	NPT1/4	11	28.5	22.7	26	20.2	17.5	9/16	24.7	7.5	29.5	1.60
PL3/8-N3UT		NPT3/8	12	32	25.9	27			11/16	37.7	8.2	32.1	1.74
PL1/2-N3UT	1/2	NPT3/8	12	32.5	26.4	29.7	23.4	21	11/16	41.4	9	43	2.33
PL1/2-N4UT		NPT1/2	15	36.5	28.4				7/8				

PV Union Elbow

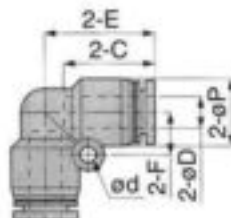

Unit: mm

Model	OD (Tube dia.)	E	C	eP	F	ød	Weight (g)	Orifice dia. (mm)	Eff. sect. Area (mm ²)	Cv
PV4T	4	17.2	14.9	10	7	3.2	5.3	2.8	3.5	0.19
PV6T	6	20.5	17	12.5	8	3.2	7.5	4.3	8.7	0.47
PV8T	8	22.9	18.4	14.5	9.5	3.2	10.4	5.9	18.6	1.01
PV10T	10	26.2	20.2	17.5	11	4.2	17.4	8.3	28.4	1.54
PV12T	12	30.5	20.4	21	12.5	4.2	24.8	8.9	40.6	2.20

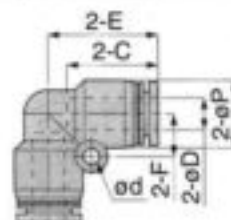

Unit: mm

Model	OD (Tube dia.)	E	C	eP	F	ød	Weight (g)	Orifice dia. (mm)	Eff. sect. Area (mm ²)	Cv
PV5/32T	5/32	17.2	14.9	10	7	3.2	5.3	2.8	3.5	0.19
PV1/4T	1/4	20.5	17	12.5	8	3.2	7.5	4.3	8.7	0.47
PV5/16T	5/16	22.9	18.4	14.5	9.5	3.2	10.4	5.9	18.6	1.01
PV3/8T	3/8	26.2	20.2	17.5	11	4.2	17.4	8.3	28.4	1.54
PV1/2T	1/2	30.5	20.4	21	12.5	4.2	24.8	8.9	40.6	2.20

PE Union Tee

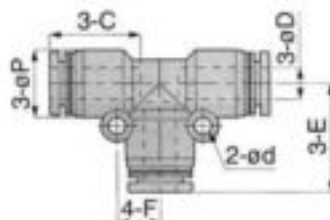

Unit: mm

Model	OD (Tube dia.)	E	C	eP	F	ød	Weight (g)	Orifice dia. (mm)	Eff. sect. Area (mm ²)	Cv
PE4T	4	17.2	14.9	10	7	3.2	8	2.8	4	0.22
PE6T	6	20.5	17	12.5	8	3.2	11.2	4.3	11.3	0.61
PE8T	8	22.9	18.4	14.5	9.5	3.2	15.7	6.5	25.5	1.38
PE10T	10	26.2	20.2	17.5	11	4.2	25.5	8.3	37.5	2.03
PE12T	12	30.5	20.4	21	12.5	4.2	36.7	9.9	47.3	2.56

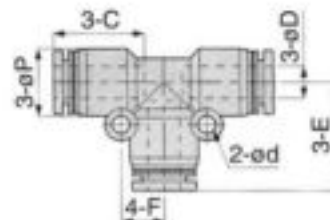

Unit: mm

Model	OD (Tube dia.)	E	C	eP	F	ød	Weight (g)	Orifice dia. (mm)	Eff. sect. Area (mm ²)	Cv
PE5/32T	5/32	17.2	14.9	10	7	3.2	8	2.8	4	0.22
PE1/4T	1/4	20.5	17	12.5	8	3.2	11.2	4.3	11.3	0.61
PE5/16T	5/16	22.9	18.4	14.5	9.5	3.2	15.7	6.5	25.5	1.38
PE3/8T	3/8	26.2	20.2	17.5	11	4.2	25.5	8.3	37.5	2.03
PE1/2T	1/2	30.5	20.4	21	12.5	4.2	36.7	9.9	47.3	2.56

PB Tee



Appearance Dimension for Metric thread

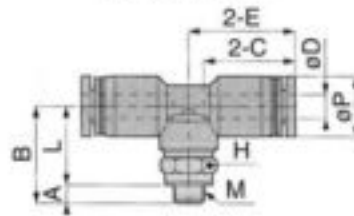

Appearance Dimension for Taper pipe thread (PT)

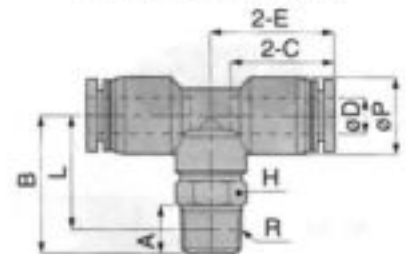

Unit: mm

Model	OD (Tube dia.)	M/R	A	B	L	E	C	oP	H (Hex.)	Weight (g)	Orifice dia. (mm)	Eff. sect. Area (mm ²)	Cv
PB4-M5T	4	M5×0.8	3	16	13	17.7	14.9	10	8	8.2	2.4	3.6	0.20
PB4-01T		R1/8	8	22	18	18.7			10	13.3	2.8	6.1	0.33
PB6-01T	6	R1/8	8	22.5	18.5	20.3	17	12.5	10	15.2	4	10.2	0.55
PB6-02T		R1/4	11	28	22	21.8			14	23.5	4.3	13	0.70
PB8-01T	8	R1/8	8	23	19	22.7	18.4	14.5	12	18.3	6	23.8	1.29
PB8-02T		R1/4	11	28	22	23.7			14	25.9	6.4	34.3	1.86
PB8-03T		R3/8	12	31	24.7	24.7			17	39.3	6.4	33	1.79
PB10-02T	10	R1/4	11	28.5	22.5	26	20.2	17.5	14	32.6	7.5	37.3	2.02
PB10-03T		R3/8	12	32	25.7	27			17	45.8	8.2	46.4	2.51
PB12-03T	12	R3/8	12	32.5	26.2	29.7	23.4	21	17	52.7	9	45.6	2.47
PB12-04T		R1/2	15	36.5	28.3				21				

Appearance Dimension for Unified thread

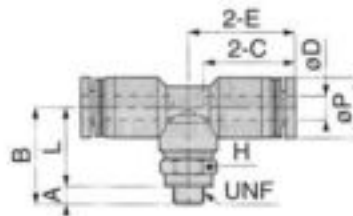

Appearance Dimension for Pipe thread general purpose (NPT)

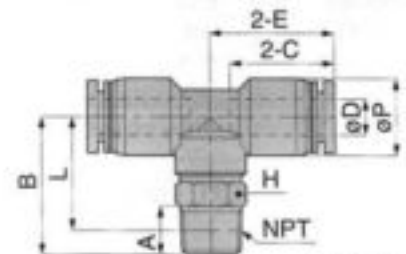

Unit: mm

Model	OD (Tube dia.)	UNF/NPT	A	B	L	E	C	oP	H (Hex.)	Weight (g)	Orifice dia. (mm)	Eff. sect. Area (mm ²)	Cv
PB5/32-U10UT	5/32	No. 10-32UNF	3	16	13	17.7	14.9	10	5/16	8.2	2.4	3.6	0.20
PB5/32-N1UT		NPT1/8	8	22	17.9	18.7			7/16	13.3	2.8	6.1	0.33
PB1/4-N1UT	1/4	NPT1/8	8	22.5	18.4	20.3	17	12.5	7/16	15.2	4	10.2	0.55
PB1/4-N2UT		NPT1/4	11	28	22.2	21.8			9/16	23.5	4.3	13	0.70
PB5/16-N1UT	5/16	NPT1/8	8	23	18.9	22.7	18.4	14.5	1/2	18.3	6	23.8	1.29
PB5/16-N2UT		NPT1/4	11	28	22.2	23.7			9/16	25.9	6.4	34.3	1.86
PB5/16-N3UT		NPT3/8	12	31	24.9	24.7			11/16	39.3	6.4	33	1.79
PB3/8-N2UT	3/8	NPT1/4	11	28.5	22.7	26	20.2	17.5	9/16	32.6	7.5	37.3	2.02
PB3/8-N3UT		NPT3/8	12	32	25.9	27			11/16	45.8	8.2	46.4	2.51
PB1/2-N3UT	1/2	NPT3/8	12	32.5	26.4	29.7	23.4	21	11/16	52.7	9	45.6	2.47
PB1/2-N4UT		NPT1/2	15	36.5	28.4				7/8				

PD Branch Tee



Appearance Dimension for Metric thread

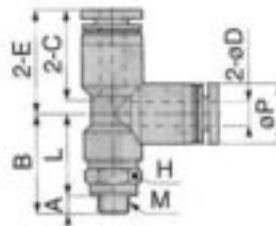

Appearance Dimension for Taper pipe thread (PT)

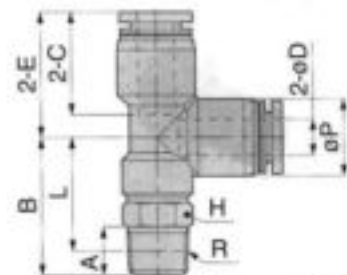

Unit: mm

Model	OD (Tube dia.)	M/R	A	B	L	E	C	eP	H (Hex.)	Weight (g)	Orifice dia. (mm)	Et. sect. Area (mm ²)	Cv
PD4-M5T	4	M5×0.8	3	16.5	13.5	17.2	14.9	10	8	8.2	2.4	3.4	0.18
PD4-01T		R1/8	8	23	19				10	13.3	2.8	5.2	0.28
PD6-01T	6	R1/8	8	22.8	18.8	20.5	17	12.5	10	15.2	4	10.4	0.56
PD6-02T		R1/4	11	28.3	22.2				14	23.3	4.3	13	0.70
PD8-01T	8	R1/8	8	23	19	22.9	18.4	14.5	12	18.4	6	24.3	1.32
PD8-02T		R1/4	11	28.8	22.8				14	26.1	6.5	33.4	1.81
PD8-03T		R3/8	12	31.5	25.2				17	39	32.3	1.75	
PD10-02T	10	R1/4	11	28.5	22.5	26.2	20.2	17.5	14	32.5	7.5	38.2	2.07
PD10-03T		R3/8	12	32	25.7				17	45.7	8.3	46.6	2.53
PD12-03T	12	R3/8	12	33	26.7	30.5	23.4	21	17	53	9	45.9	2.49
PD12-04T		R1/2	15	37	28.8				21				

Appearance Dimension for Unified thread

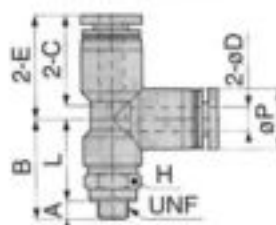

Appearance Dimension for Pipe thread general purpose (NPT)

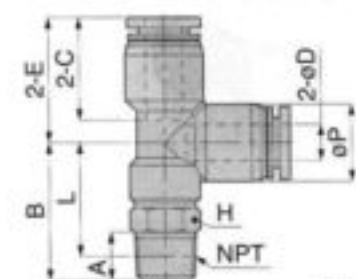

Unit: mm

Model	OD (Tube dia.)	UNF/NPT	A	B	L	E	C	eP	H (Hex.)	Weight (g)	Orifice dia. (mm)	Et. sect. Area (mm ²)	Cv
PD5/32-U10UT	5/32	No. 10-32UNF	3	16.5	13.5	17.2	14.9	10	5/16	8.2	2.4	3.4	0.18
PD5/32-N1UT		NPT1/8	8	23	18.9				7/16	13.3	2.8	5.2	0.28
PD1/4-N1UT	1/4	NPT1/8	8	22.8	18.6	20.5	17	12.5	7/16	15.2	4	10.4	0.56
PD1/4-N2UT		NPT1/4	11	28.3	22.5				9/16	23.3	4.3	13	0.70
PD5/16-N1UT	5/16	NPT1/8	8	23	18.9	22.9	18.4	14.5	1/2	18.4	6	24.3	1.32
PD5/16-N2UT		NPT1/4	11	28.8	23				9/16	26.1	6.5	33.4	1.81
PD5/16-N3UT		NPT3/8	12	31.5	25.4				11/16	39	32.3	1.75	
PD3/8-N2UT	3/8	NPT1/4	11	28.5	22.7	26.2	20.2	17.5	9/16	32.5	7.5	38.2	2.07
PD3/8-N3UT		NPT3/8	12	32	25.9				11/16	45.7	8.3	46.6	2.53
PD1/2-N3UT	1/2	NPT3/8	12	33	26.9	30.5	23.4	21	11/16	53	9	45.9	2.49
PD1/2-N4UT		NPT1/2	15	37	28.9				7/8				

PH Universal Elbow



Appearance Dimension for Metric thread

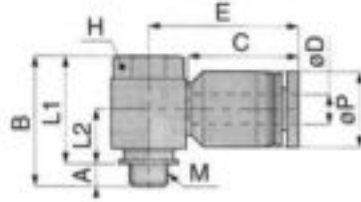

Appearance Dimension for Taper pipe thread (PT)

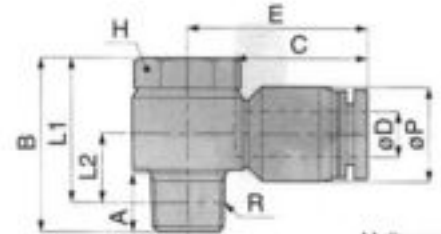

Unit: mm

Model	OD (Tube dia.)	M/R	A	B	L1	L2	E	C	oP	H (Hex.)	Weight (g)	Orifice dia. (mm)	Et. sect. Area (mm ²)	Cv
PH4-M5T	4	M5×0.8	3	17.1	14.1	7.1	19.9	14.9	10	8	7.5	2.4	2.6	0.14
PH4-01T		R1/8	8	24.7	20.7	10.7	21.4			12	17.8	2.8	4.1	0.22
PH6-01T	6	R1/8	8	24.7	20.7	10.9	23.5	17	12.5	12	18.6	4.3	7.1	0.38
PH6-02T		R1/4	11	28.7	22.7	12.1	25.5			14	28.4	6.2	8.6	0.47
PH8-01T	8	R1/8	8	24.7	20.7	11.9	26.9	18.4	14.5	12	20.1	6	9.9	0.54
PH8-02T		R1/4	11	28.7	22.7	13.1	28.4			14	29.9	7	10.7	0.58
PH10-02T	10	R1/4	11	28.7	22.7	14.7	30.9	20.2	17.5	14	33	7.3	10.2	0.55
PH10-03T		R3/8	12	34.5	28.2	15.5	31.2			19	61	9	20.3	1.10
PH12-03T	12	R3/8	12	34.5	28.2	17.2	36.9	23.4	21	19	65	9	20.3	1.10
PH12-04T		R1/2	15	41.2	33	18.8	36.4			24	122			

Appearance Dimension for Unified thread

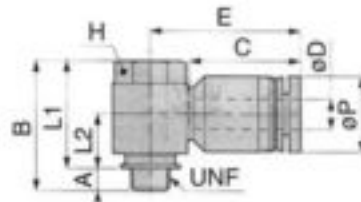

Appearance Dimension for Pipe thread general purpose (NPT)

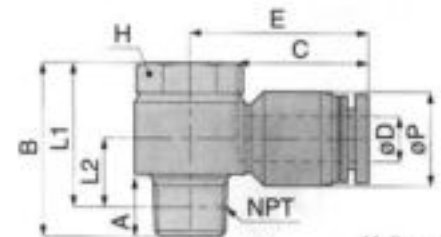

Unit: mm

Model	OD (Tube dia.)	UNF/NPT	A	B	L1	L2	E	C	oP	H (Hex.)	Weight (g)	Orifice dia. (mm)	Et. sect. Area (mm ²)	Cv
PH5/32-U10UT	5/32	No. 10-32UNF	3	17.1	14.1	7.1	19.9	14.9	10	5/16	7.5	2.4	2.6	0.14
PH5/32-N1UT		NPT1/8	8	24.7	20.6	10.6	21.4			7/16	17.8	2.8	4.1	0.22
PH1/4-N1UT	1/4	NPT1/8	8	24.7	20.6	10.8	23.5	17	12.5	7/16	18.6	4.3	7.1	0.38
PH1/4-N2UT		NPT1/4	11	28.7	22.9	12.3	25.5			9/16	28.4	6.2	8.6	0.47
PH5/16-N1UT	5/16	NPT1/8	8	24.7	20.6	11.8	26.9	18.4	14.5	7/16	20.1	6	9.9	0.54
PH5/16-N2UT		NPT1/4	11	28.7	22.9	13.3	28.4			9/16	29.9	7	10.7	0.58
PH3/8-N2UT	3/8	NPT1/4	11	28.7	22.9	14.9	30.9	20.2	17.5	9/16	33	7.3	10.2	0.55
PH3/8-N3UT		NPT3/8	12	34.5	28.4	15.7	31.2			3/4	61	9	20.3	1.10
PH1/2-N3UT	1/2	NPT3/8	12	34.5	28.4	17.4	36.9	23.4	21	3/4	65	9	20.3	1.10
PH1/2-N4UT		NPT1/2	15	41.2	33.1	18.9	36.4			1	122			

PX Branch Y



Appearance Dimension for Metric thread

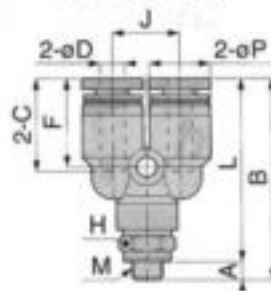

Appearance Dimension for Taper pipe thread (PT)

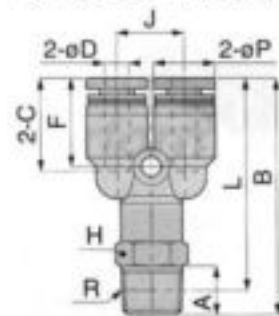

Unit: mm

Model	OD (Tube dia.)	M/R	A	B	L	ød	C	øP	F	J	H (Hex.)	Weight (g)	Orifice dia. (mm)	Eff. sec. Area (mm ²)	Cv
PX4-M5T	4	M5×0.8	3	32.9	29.9	3.2	14.9	10	14.2	11	8	8.7	2.1	3.4	0.18
PX4-01T		R1/8	8	38.4	34.4						10	13.4		4.7	0.25
PX6-01T	6	R1/8	8	41.3	37.3	3.2	17	12.5	15.8	12	10	15.9	4	10.3	0.56
PX6-02T		R1/4	11	51.8	45.7						4.2	14.5		17.3	14
PX8-01T	8	R1/8	8	47.7	43.7	4.2	18.4	14.5	17.2	14	12	19.9	5.4	20	1.08
PX8-02T		R1/4	11	51.7	45.7						14	27.2		23.6	1.28
PX8-03T		R3/8	12	58.1	51.8						17.5	19.2	18	17	44.4
PX10-02T	10	R1/4	11	56.4	50.4	4.2	20.2	17.5	19.5	18	14	35	7.5	35.9	1.95
PX10-03T		R3/8	12	58.4	52.1						17	47.7		8.3	42.5
PX12-03T	12	R3/8	12	60.6	54.3	4.2	23.4	21	22.2	20	17	55.3	8.9	45.7	2.48
PX12-04T		R1/2	15	64.6	56.4						21				

Appearance Dimension for Unified thread

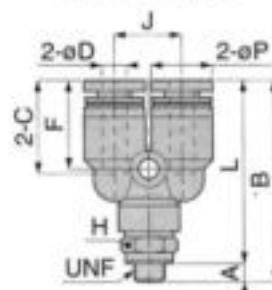

Appearance Dimension for Pipe thread general purpose (NPT)

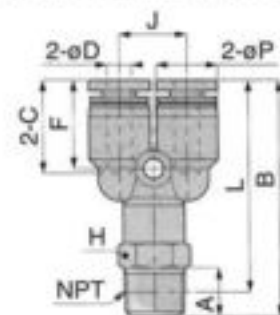

Unit: mm

Model	OD (Tube dia.)	UNF/NPT	A	B	L	ød	C	øP	F	J	H (Hex.)	Weight (g)	Orifice dia. (mm)	Eff. sec. Area (mm ²)	Cv
PX5/32-U10UT	5/32	1/16 UNF	3	32.9	29.9	3.2	14.9	10	14.2	11	5/16	8.7	2.1	3.4	0.18
PX5/32-N1UT		NPT1/8	8	38.4	34.3						7/16	13.4		4.7	0.25
PX1/4-N1UT	1/4	NPT1/8	8	41.3	37.1	3.2	17	12.5	15.8	12	7/16	15.9	4	10.3	0.56
PX1/4-N2UT		NPT1/4	11	51.8	46						4.2	14.5		17.3	14
PX5/16-N1UT	5/16	NPT1/8	8	47.7	43.6	4.2	18.4	14.5	17.2	14	1/2	19.9	5.4	20	1.08
PX5/16-N2UT		NPT1/4	11	51.7	45.9						14	27.2		23.6	1.28
PX5/16-N3UT		NPT3/8	12	58.1	52						17.5	19.2	18	11/16	44.4
PX3/8-N2UT	3/8	NPT1/4	11	56.4	50.6	4.2	20.2	17.5	19.5	18	9/16	35	7.5	35.9	1.95
PX3/8-N3UT		NPT3/8	12	58.4	52.3						11/16	47.7		8.3	42.5
PX1/2-N3UT	1/2	NPT3/8	12	60.6	54.5	4.2	23.4	21	22.2	20	11/16	55.3	8.9	45.7	2.48
PX1/2-N4UT		NPT1/2	15	64.6	56.5						7/8				

PY Union Y

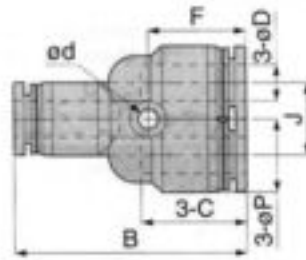

Unit: mm

Model	OD (Tube dia.)	B	eP	C	ed	J	F	Weight (g)	Orifice dia. (mm)	Eff. sect. Area (mm ²)	Cv
PY4T	4	32.8	10	14.9	3.2	11	14.1	7.7	2.1	2.5	0.14
PY6T	6	37.7	12.5	17	3.2	12	15.8	10.8	4.1	8.7	0.47
PY8T	8	42.4	14.5	18.4	3.2	14	17.2	15.2	5.3	16.7	0.91
PY10T	10	48.4	17.5	20.2	4.2	18	19.5	25.3	8.1	33.1	1.79
PY12T	12	54.8	21	23.4	4.2	20	22.2	36.3	8.6	37.8	2.05

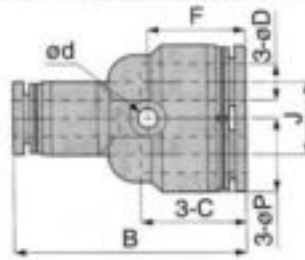

Unit: mm

Model	OD (Tube dia.)	B	eP	C	ed	J	F	Weight (g)	Orifice dia. (mm)	Eff. sect. Area (mm ²)	Cv
PY5/32T	5/32	32.8	10	14.9	3.2	11	14.1	7.7	2.1	2.5	0.14
PY1/4T	1/4	37.7	12.5	17	3.2	12	15.8	10.8	4.1	8.7	0.47
PY5/16T	5/16	42.4	14.5	18.4	3.2	14	17.2	15.2	5.3	16.7	0.91
PY3/8T	3/8	48.4	17.5	20.2	4.2	18	19.5	25.3	8.1	33.1	1.79
PY1/2T	1/2	54.8	21	23.4	4.2	20	22.2	36.3	8.6	37.8	2.05

PW Different Diam. Union Y

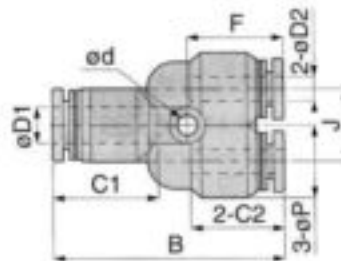

Unit: mm

Model	OD1 (Tube dia.)	OD2 (Tube dia.)	B	eP	C1	C2	ed	J	F	Weight (g)	Orifice dia. (mm)	Eff. sect. Area (mm ²)	Cv
PW6-4T	6	4	37.2	12.5	17	14.9	3.2	12	15.2	10.4	3.8	4	0.22
PW8-6T	8	6	42.5	14.5	18.4	17	3.2	14	17.3	14.4	5.8	6.3	0.34
PW10-8T	10	8	48.1	17.5	20.2	18.4	4.2	18	19.2	22.2	8.2	22	1.19
PW12-10T	12	10	54.6	21	23.4	20.2	4.2	20	22	34.8	7.9	35.9	1.95

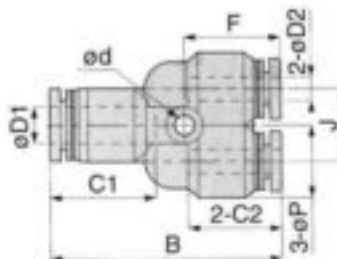

Unit: mm

Model	OD1 (Tube dia.)	OD2 (Tube dia.)	B	eP	C1	C2	ed	J	F	Weight (g)	Orifice dia. (mm)	Eff. sect. Area (mm ²)	Cv
PW1/4-5/32T	1/4	5/32	37.2	12.5	17	14.9	3.2	12	15.2	10.4	3.8	4	0.22
PW5/16-1/4T	5/16	1/4	42.5	14.5	18.4	17	3.2	14	17.3	14.4	5.8	6.3	0.34
PW3/8-5/16T	3/8	5/16	48.1	17.5	20.2	18.4	4.2	18	19.2	22.2	8.2	22	1.19
PW1/2-3/8T	1/2	3/8	54.6	21	23.4	20.2	4.2	20	22	34.8	7.9	35.9	1.95