

MVSI-260 series

ISO-1 SOLENOID VALVE



Specification:

Model	MVSI-260-4E1	MVSI-260-4E2	MVSI-260-4E2C.P.R
No. of port	5		
No. of position	2	2	3
Medium	Air		
Operating pressure range	2~7 kgf/cm ²		3~7 kgf/cm ²
Proof pressure	10.5 kgf/cm ²		
Effective orifice	22 mm ²		20 mm ²
Response time	40 ms		
Ambient temperature	-5~+50°C (No freezing)		
Voltage	AC110V, 220V (50/60)Hz, DC24V		
Power consumption	AC=6/4.9VA, DC=2.5W		
Available voltage range	±10%		
Insulation class	F class		
Weight	312 g	422 g	572 g

Order example of valve:

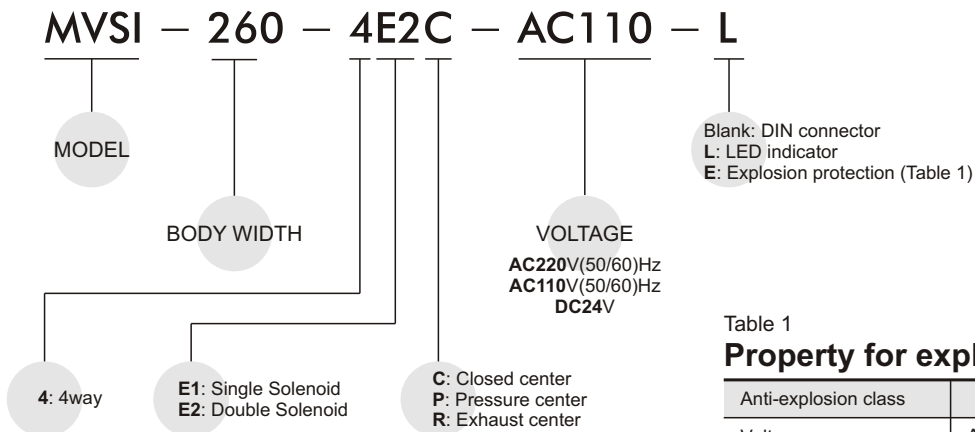

Table 1
Property for explosion-proof type

Anti-explosion class	EEx m II T4
Voltage	AC110V, 220V, (50/60)Hz, DC24V.
Power consumption	AC=4.4VA DC=5W
Available voltage range	±10%
Insulation class	F class

MVSI-260

ISO-1 SOLENOID VALVE



Dimensions:

MVSI-260-4E1

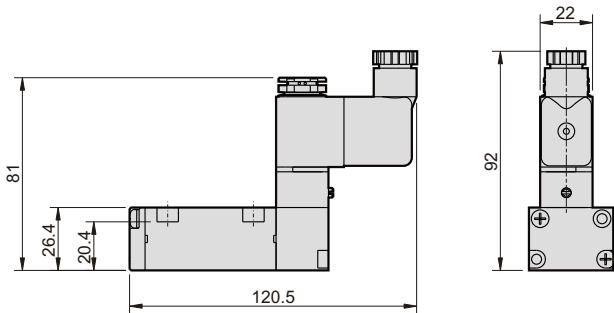
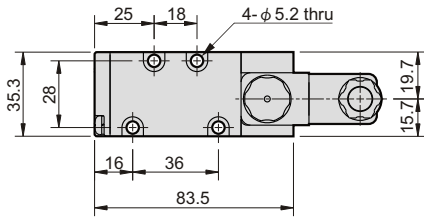

MVSI-260-4E2

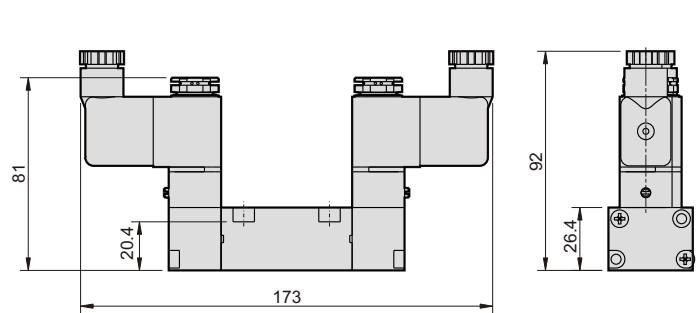
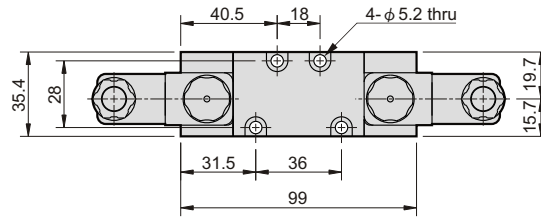
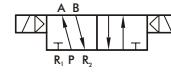

MVSI-260-4E2C.P.R

MVSI-260-4E2C



MVSI-260-4E2P



MVSI-260-4E2R

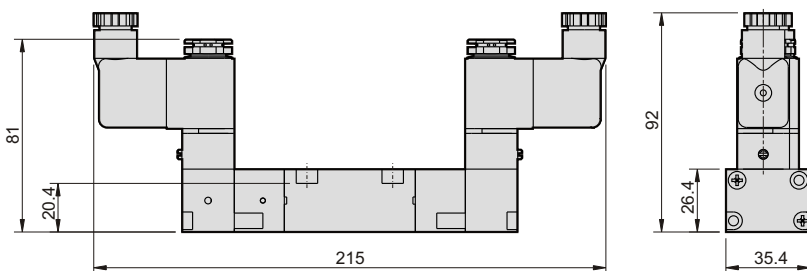
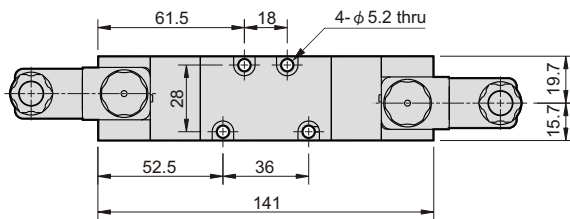
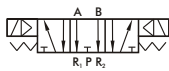

Accessories

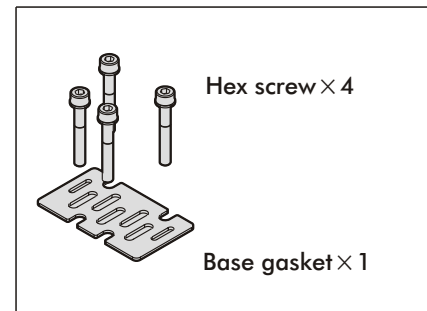

Flow features:

