

BARRIER WRENCHES

The unique "MERRY" Barrier Wrenches have solved the problem of difficult bolt / nut fastening and loosening jobs in narrow and hard-to-reach places.

(Fastening torque is transferred through a chain.)

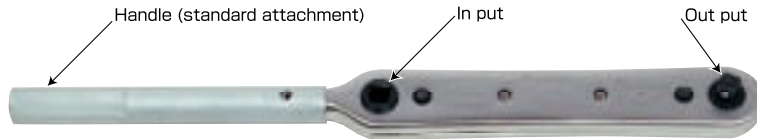

- Grip the handles of both Barrier Wrench and ratchet wrench together for multiplied power.

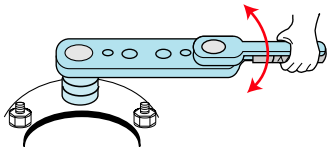

- Joint panels of three different styles are available to connect two Barrier Wrenches. (Only for YL2)

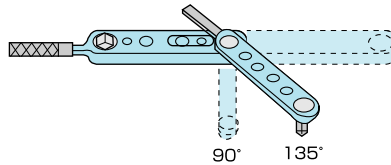

- General use with ratchet wrench

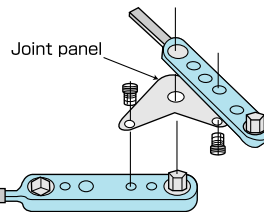
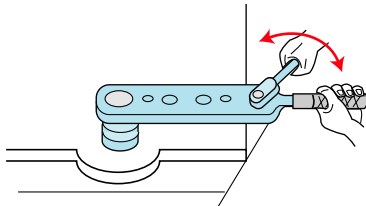

- Impact Wrench can be used instead of a ratchet wrench **only for YL2.** (Torque should not exceed 180N-m.)

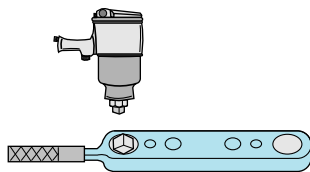

Joint panels (optional attachments)

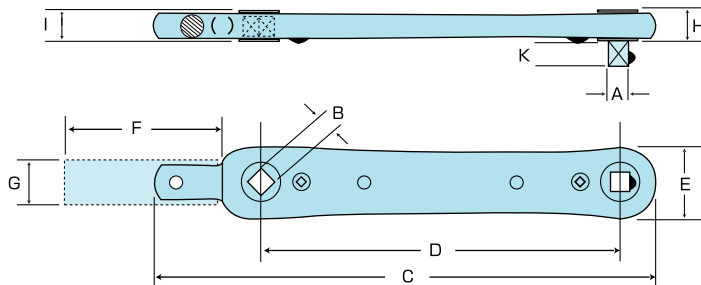
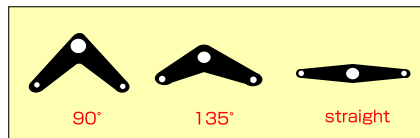

Model No.	Square size A × B	C	D	E	F	G	H	I	K	Weight	Max. allowable torque
YL1A	凸 9.5□ × 凹 9.5□	300	217	39	150	φ20	18	22	10	820g	94N-m (9.6kgf-m)
YL1B	凸 12.7□ × 凹 9.5□	300	217	39	150	φ20	18	22	14		
YL2	凸 12.7□ × 凹 12.7□	327	228	49	210	φ26	20	25	14	1,330g	196N-m (20kgf-m)
YL2A										1,030g	

AN EXAMPLE OF APPLICATION

Barrier Wrenches offer safe and smooth service for replacement or adjustment of the cultivator blades in narrow space.



OTHER EXAMPLES OF APPLICATION

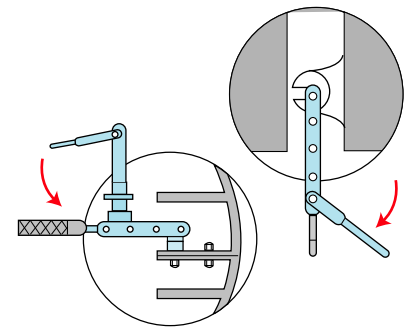

Machine installation

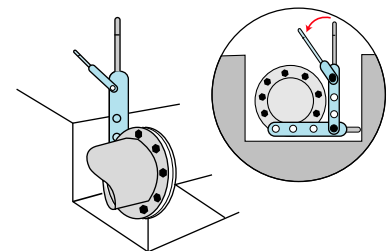

Piping construction

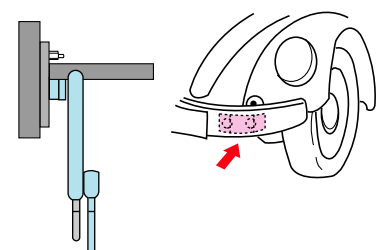

Vehicles repair-service